

Linear Solenoids

Frame Solenoids – Bistable

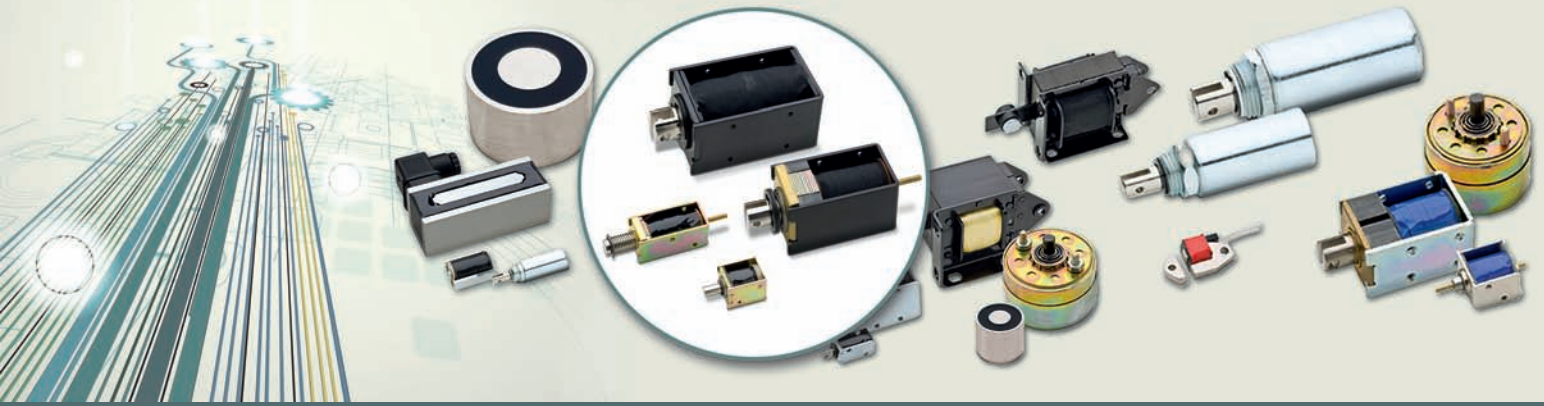

Small Frame / Both sides are fixed / For Over-Current

STSX-48

Type

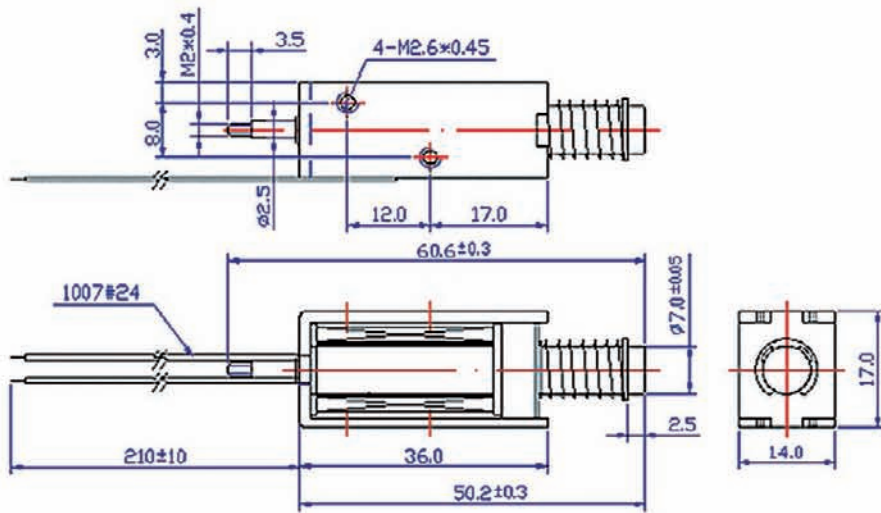

Description

Bistable linear solenoid, based on frame mode construction.

Two permanent magnets keep solenoid activated even without power supply. Mainly used for locking devices without constant power supply.

Coil Data

Stroke: 4 mm

Watt: 8

retracted (without current): 10 N

extended (without current): 2 N

Solenoid Model

Current:

12 VDC (standard)

24 VDC (standard)

Please ask for other options.

Special Development On Request

Please contact us for your custom designed part (frame, force, special application, etc.)



SHENG TENG GmbH
VAT-ID: DE 271 696 661
General Manager:
Silvio Bruske / Frank Loeffler
District Court Munich reg. # HRB185777

Angerbrunnenstraße 11
D-85356 Freising
GERMANY

Phone: +49-8161-986 44 84
Fax: +49-8161-986 44 74
eMail: office@shengteng.de

www.shengteng.de