

Electromagnets

Permanent Electromagnets

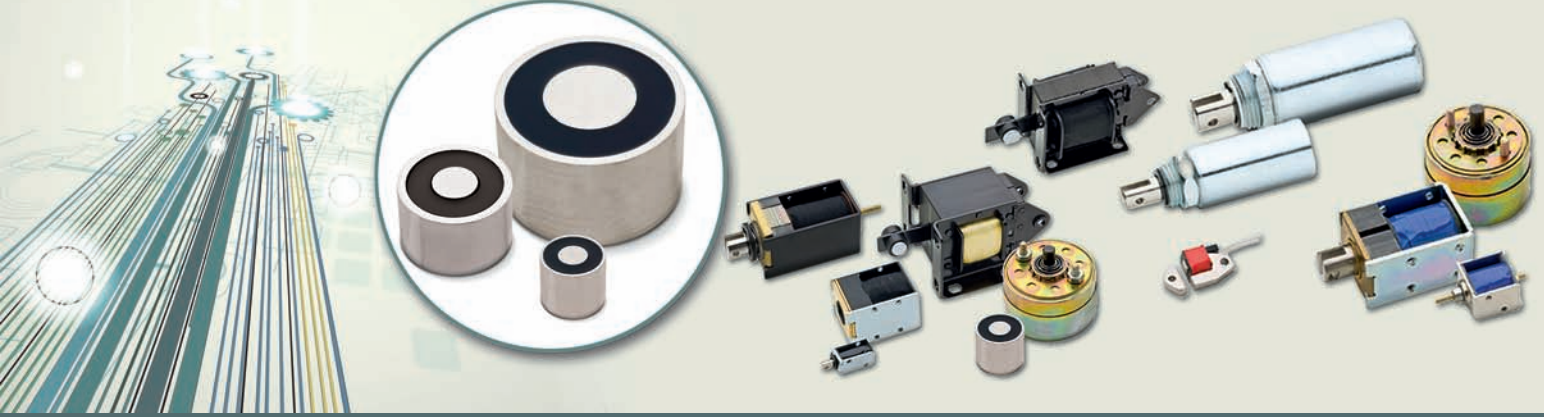

Sealed / Strong / Extremely Energy-Efficient

STSP-900720

Type

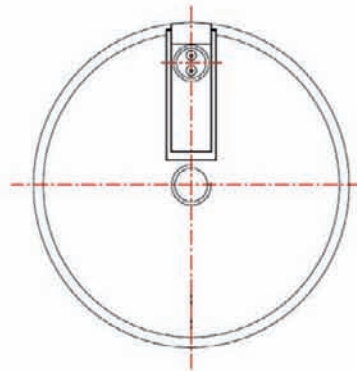
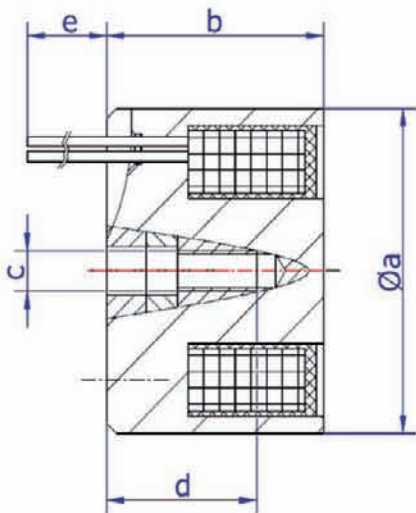

Description

Weight: 900 g

Power: 15,0 Watt

Holdingforce: 720 N

Mounting plates (minimum): 25 mm

Dimension

a	b	c	d	e
70	45	M8	25	200

Solenoid Model

Current:

24 VDC (standard)

Special Development On Request

Please contact us for your custom designed part (frame, force, special application, etc.)



SHENG TENG GmbH

VAT-ID: DE 271 696 661

General Manager:

Silvio Bruske / Frank Loeffler

District Court Munich reg. # HRB185777

Angerbrunnenstraße 11

D-85356 Freising

GERMANY

Phone: +49-8161-986 44 84

Fax: +49-8161-986 44 74

eMail: office@shengteng.de

www.shengteng.de