

Electromagnets

Permanent Electromagnets



Sealed / Strong / Extremely Energy-Efficient

STSP-7045

Type

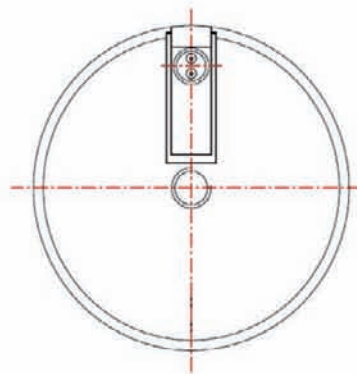
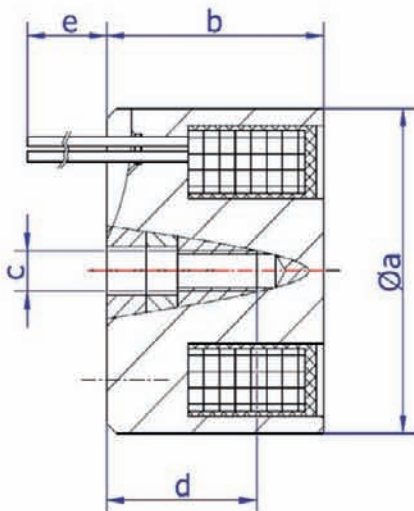

Description

Weight: 70 g
Power: 6,0 Watt
Holdingforce: 45 N
Mounting plates (minimum): 7 mm

Dimension

a	b	c	d	e
20	25	M4	14	200

Solenoid Model

Current:
24 VDC (standard)

Special Development On Request

Please contact us for your custom designed part (frame, force, special application, etc.)



SHENG TENG GmbH
VAT-ID: DE 271 696 661
General Manager:
Silvio Bruske / Frank Loeffler
District Court Munich reg. # HRB185777

Angerbrunnenstraße 11
D-85356 Freising
GERMANY

Phone: +49-8161-986 44 84
Fax: +49-8161-986 44 74
eMail: office@shengteng.de

www.shengteng.de